

DS-NLT98MG/C

98-inch 4K Interactive Display



The Hikvision Interactive Flat Panel is a kind of newly developed intelligent teaching assistance product which integrates with the latest technologies of touch control, HD display, video processing, network communication, interactive control, and sound control. It can be widely applied to the classroom, online teaching, training center, etc.

- UHD 4K display with resolution of 3840 × 2160.
- Anti-glare and anti-blocking design to ensure smooth interaction.
- Dual systems of Android and Windows (optional with OPS) saving cost and easy to use, video conference software are recommended to run under Windows system.
- Quick response, at most 50-point touch control and smooth writing experience.
- Built-in network switch chip saves a network switch.
- All-in-one design with tempered glass and intelligent temperature control, making it environmental-friendly and safety-guaranteed, support blue light protection.
- EDLA Certified

□ Specification

Product Model	
Product Model	DS-NLT98MG/C
Display	
Screen Size	98 inch
Backlight	DLED
Pixel Pitch	0.5622 (W) × 0.5622 (H) mm
Resolution	3840 × 2160 @60 Hz
Brightness	600 cd/m ² (Typ.)
Color Depth	10 bit
Display Color	1.07 G
Response Time	5 ms
Panel Type	VA
Contrast Ratio	5000:1 (Static) 30,000:1 (Dynamic)
Color Gamut	72% NTSC (CIE1931) (Typ.)
Refresh Rate	60 Hz
Viewing Angle	178° (H)/178° (V)
Aspect Ratio	16:9
Surface Hardness	9H (Pencil) 7 (Mohs)
Surface Glass	Anti-Glare Glass
Surface Haze	25% Haze
Glass Bonding Method	Zero Lamination
Display Area	2158.848 mm × 1214.352 mm
Working Duration	7 × 16 H
Transmittance	88% ± 3
Lifespan	50,000 hours
Touch	
Type	
Touch Point	Infrared Touch Screen
Touch Response Time	Up to 50-point multi-touch
Minimum Touch Object	≤ 2 ms
Touch Precision	≥ 1.5 mm (≥ 90% touching area)
Touch Resolution	± 0.5 mm (≥ 90% touching area)
Built-in System	32767 × 32767
Operation System	
Memory	Android 13.0
Built-in Storage	8 GB
Processor	128 GB
GPU	Quad-core Cortex-A76 × 4 (2.4 GHz) and quad-core Cortex-A55 × 4 (1.8 GHz)
HDCP Version	Mali-G610 MC4
Camera	2.3
Pixel	
Camera Function	Pixel 48 MP for Photos & 8 MP for Video
	Support intelligent switching among Android system, OPS, and PC.

Field Angle	93.4° (diagonal), 84.5° (horizontal), 54.1° (vertical)
Distortion	≤ 2.5%
Camera Resolution Ratio	Up to 4K
Microphone	
Specification	Omni-directional 8-array layout
Mic Function	Echo reduction and smart noise-cancellation
Voice Distance	12 m
Sampling Rate	32 K
Mic Depth	16 bit
Internal Function	
Loudspeaker	Built-in 2 × 20 W + 25 W loudspeaker;
Bluetooth	Built-in BLE (Bluetooth Low Energy) module supports Bluetooth 5.1
NFC	Support screen mirroring by Android phones
Light Sensor	Yes
Image Processing Technology	Support 3D digital noise reduction, face detection, automatic white balance, automatic purple edge removal, automatic defogging; support shadow correction.
Audio Processing Technology	Support dereverberation, adaptive noise reduction, adaptive non-stationary noise reduction, adaptive echo cancellation, automatic gain control, automatic electrical level control, sound source localization, speech dynamic detection, digital beam forming, speech detection.
Interface	
Video & Audio Input	HDMI In (HDMI 2.0) × 3, VGA In × 1, DP In (DP 1.2) × 1, Audio In × 1
Video & audio output	HDMI Out (HDMI 2.0) × 1, Audio Out × 1, SPDIF Out × 1
Control interface	TOUCH-USB 3.0 × 3, RS232 × 1
Network Interface	LAN (1000 Mbps) × 2 WIFI AP & Station, 2.4G/5G WIFI 6, IEEE 802.11 a/b/g/n/ac/ax 2 × 2 MIMO (2.4 GHz and 5 GHz) authentication protocols WEP, WPA, WPA2, PSK and 802.1X EAP
Data Transmission Interface	USB 3.0 × 4, USB 2.0 × 1, Type-C × 2 (Type-C supports USB 2.0, DP 1.2, and charging functions; side charging 15 W, front charging 65 W)
Power	
Power Supply	100 to 240 VAC, 50/60 Hz
Standby Consumption	≤ 0.5 W
Average Consumption	< 325 W
General	
VESA	1000 mm × 400 mm (4 × M8-20 mm)
Product dimensions	2219.8 mm × 1336.4 mm × 105.7 mm
Accessory	Wall mount bracket, hook, user manual, touch writing pen, packing list, 3 M touch USB cable, 3.5 M HDMI cable (2.0), power cable , bluetooth remote control.
Package Dimensions (W × H × D)	2520 mm × 330 mm × 1700 mm
Net Weight	94 kg
Gross Weight	137 kg
Working Environment	
Working Temperature	0 °C to 40 °C (32 °F to 104 °F)
Working Humidity	10%~90% RH

Physical Interface

Interface	Description	Interface	Description
1.SPDIIF	Audio input interface	2.Line OUT	Audio output interface
3.Line IN	Type-C interface	4.VGA IN	Video devices connection interface
5.TYPE-C 2	Peripheral touch interface	6.DP IN	Display input interface
7.TOUCH-USB 2	Peripheral touch interface	8.HDMI IN 2	HDMI 2 input interface
9.TOUCH-USB 1	USB interface	10.HDMI IN 1	HDMI 1 input interface
11.USB	Multi-functional USB interface	12.MULTI-USB 2	Multi-functional USB interface
13.MULTI-USB 1	RS 232 interface	14.HDMI OUT	HDMI output interface
15. RS 232	Network interface 2	16. LAN 1	Network interface 1
17.LAN 2	Power Switch	18. Power Button	Power Button
19. Power Switch	USB interface		
A. USB	Multi-functional USB interface	B. USB	USB interface
C. MULTI-USB	TOUCH-USB interface	D. HDMI IN	HDMI IN interface
E. TOUCH-USB			

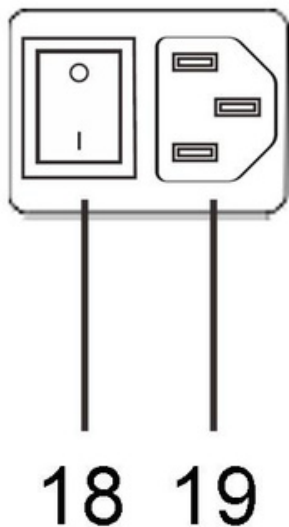
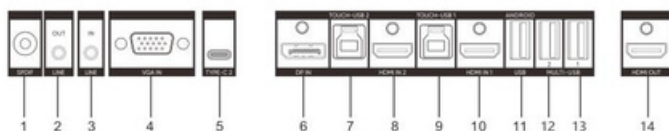

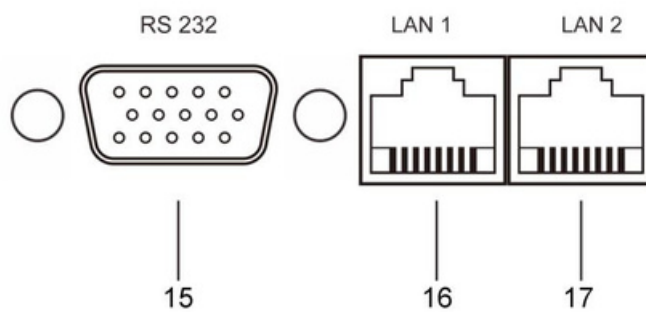
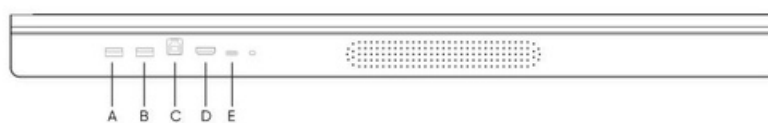

□ Installation

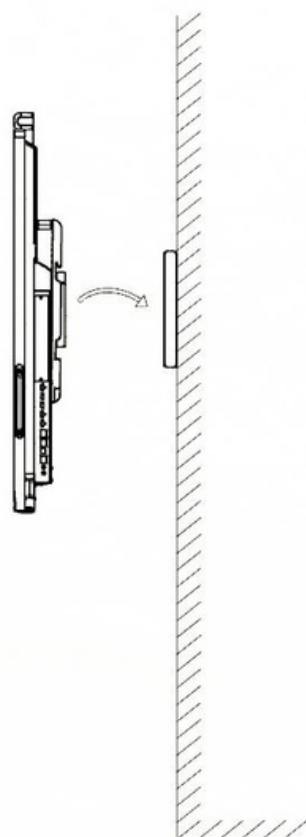

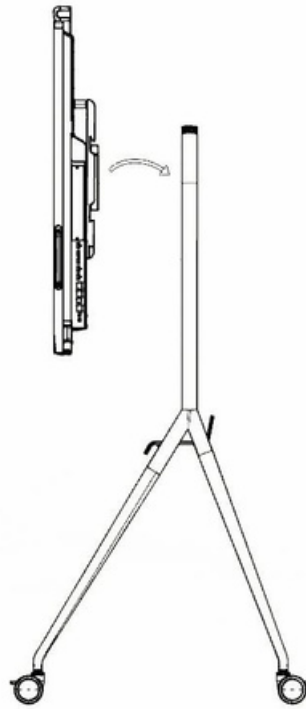

- Available Model
DS-NLT98MG/C

□ Dimension

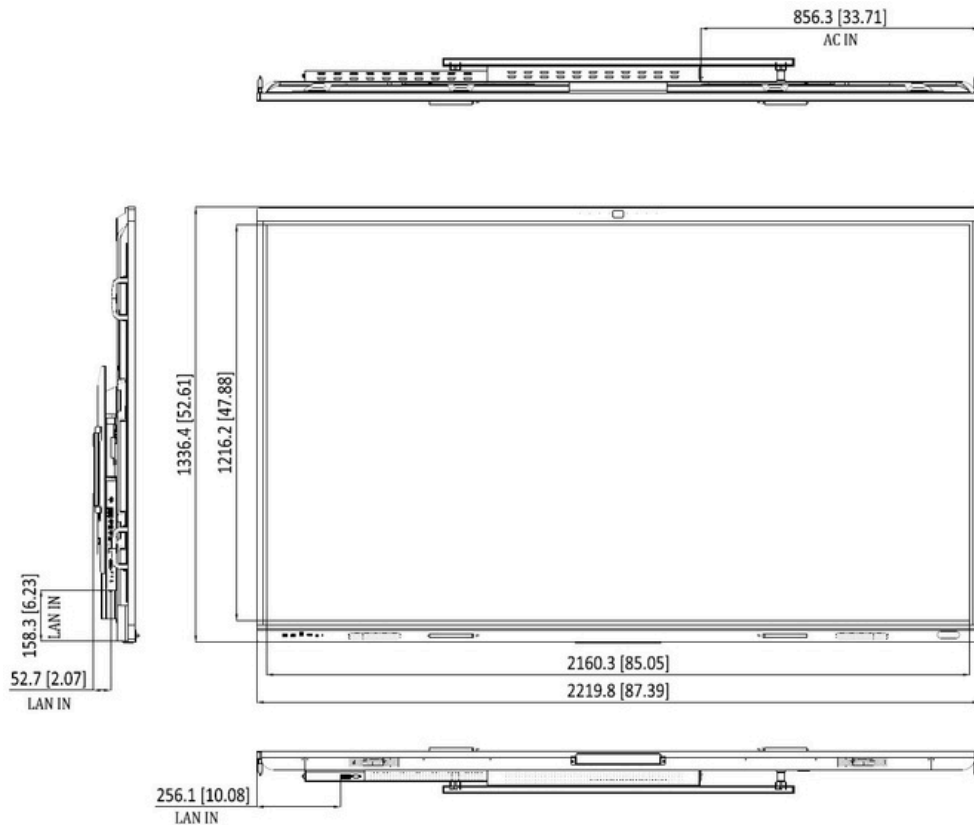

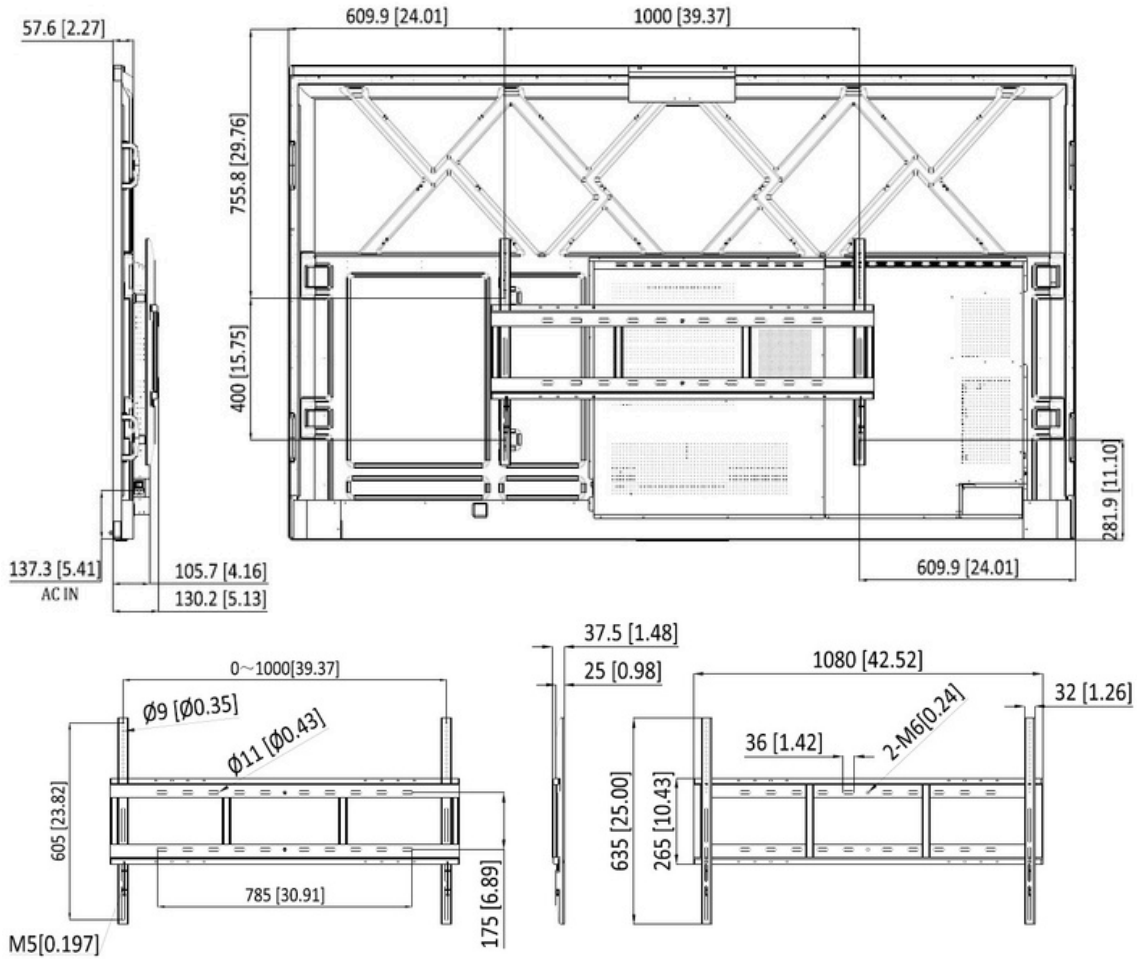

- Accessory
- Optional

DS-D5ABKY2-B 86" Conference Flat Panel Brackets	DS-D5SC3B-B Wireless Dongle	DS-D5SC3B-W Wireless Dongle	DS-D5AC12T5-8S2 OPS Module	DS-D5AC12T7-16S5 OPS Module
				

Headquarters

No.555 Qianmo Road, Binjiang District,
Hangzhou 310051, China
T +86-571-8807-5998
www.hikvision.com



Follow us on social media to get the latest product and solution information.

